

### FEATURES

- Electrically Isolated by DBC Ceramic
- High Surge Current Capability
- Low Inductance Package

### APPLICATIONS

- DC Motor Control and Drives
- Battery Charges ,Heater controls, Light dimmers
- Static switches

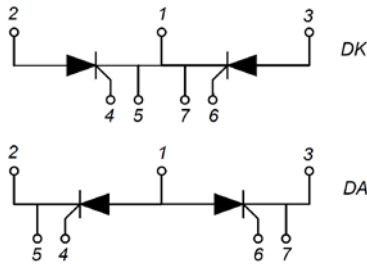

### ABSOLUTE MAXIMUM RATINGS

$T_c=25^{\circ}\text{C}$  unless otherwise specified

Symbol	Parameter/Test Conditions	Values		Unit
		MMK110A160DA	MMK110A160DK	
$V_{\text{DRM}}$	Repetitive Peak Off-State Voltage	1600	1600	V
$V_{\text{RRM}}$	Repetitive Peak Reverse Voltage	1600	1600	
$V_{\text{RSM}}$	Non-Repetitive Peak Reverse Voltage	1700	1700	

Symbol	Parameter	Test Conditions	Values	Unit
$I_{\text{T(AV)}}$	Average On-State Current	Single phase, half wave, 180°conduction, $T_c=80^{\circ}\text{C}$	110	A
$I_{\text{T(RMS)}}$	R.M.S. On-State Current		170	
$I_{\text{TSM}}$	Non-Repetitive Surge	1/2 cycle, 50HZ, peak value $T_c =45^{\circ}\text{C}$	2000	
	On-State Current	1/2 cycle, 60HZ, peak value $T_c =45^{\circ}\text{C}$	2200	
$I^2t$	$I^2t$ (For Fusing)	1/2 cycle, 50HZ, peak value $T_c =45^{\circ}\text{C}$	20	$\text{KA}^2\text{s}$
		1/2 cycle, 60HZ, peak value $T_c =45^{\circ}\text{C}$	20	$\text{KA}^2\text{s}$
$T_{\text{J}}$	Junction Temperature		-40 to +125	$^{\circ}\text{C}$
$T_{\text{STG}}$	Storage Temperature Range		-40 to +125	$^{\circ}\text{C}$
$V_{\text{ISO}}$	Isolation Breakdown Voltage	AC, 50Hz(R.M.S), $t=1$ minute	3000	V
Torque	Module-to-Sink	Recommended (M5)	2.5~5	N.m
Torque	Module Electrodes	Recommended (M5)	2.5~5	N.m
$R_{\text{th(J-C)}}$	Junction-to-Case Thermal Resistance		0.24	$\text{K/W}$
Weight			110	g

MacMic Science & Technology Co., Ltd.

Add: #18, Hua Shan Zhong Lu, New District, Changzhou City, Jiangsu Province, P. R .of China

Tel.: +86-519-85163708 Fax: +86-519-85162291 Post Code: 213022 Website: [www.macmicst.com](http://www.macmicst.com)

## MMK110A160DA/DK

### ELECTRICAL AND THERMAL CHARACTERISTICS $T_C=25^\circ\text{C}$ unless otherwise specified

Symbol	Parameter	Test Conditions	Min.	Typ.	Max.	Unit
$I_{DRM}$	Maximum Peak Off-State Current	$V_D = V_{DRM}, T_J = 125^\circ\text{C}$			15	mA
$I_{RRM}$	Maximum Peak Reverse Current	$V_R = V_{RRM}, T_J = 125^\circ\text{C}$			15	
$V_{TM}$	Maximum on-state voltage drop	$I_{TM} = 345\text{A}, t_d = 10\text{ ms, half sine}$			1.8	V
$V_{T0}$	For power-loss calculations only $T_J = 125^\circ\text{C}$				0.88	V
$r_T$					3.1	m $\Omega$
$V_{GT}$	Max. required DC gate voltage to trigger	$V_A = 6\text{V}, R_A = 1\Omega, T_J = -40^\circ\text{C}$			4	V
		$V_A = 6\text{V}, R_A = 1\Omega$			2.5	
		$V_A = 6\text{V}, R_A = 1\Omega, T_J = 125^\circ\text{C}$			1.7	
$I_{GT}$	Max. required DC gate current to trigger	$V_A = 6\text{V}, R_A = 1\Omega, T_J = -40^\circ\text{C}$			270	mA
		$V_A = 6\text{V}, R_A = 1\Omega$			150	
		$V_A = 6\text{V}, R_A = 1\Omega, T_J = 125^\circ\text{C}$			80	
$V_{GD}$	Max. required DC gate voltage not to trigger, $V_D = V_{DRM}, T_J = 125^\circ\text{C}$				0.25	V
$I_{GD}$	Max. required DC gate current not to trigger, $V_D = V_{DRM}, T_J = 125^\circ\text{C}$				10	mA
$I_H$	Maximum holding current			125	250	
$I_L$	Maximum latching current			250	500	
$P_{GM}$	Maximum peak gate power				10	W
$P_{G(AV)}$	Maximum average gate power				2.5	W
$I_{GM}$	Maximum peak gate current				2.5	A
$-V_{GM}$	Maximum peak negative gate voltage				10	V
dv/dt	Critical Rate of Rise of Off-State Voltage, $T_J = 125^\circ\text{C}$ , exponential to 67% rated $V_{DRM}$				1000	V/ $\mu\text{s}$
di/dt	$V_D = 2/3V_{DRM}, I_G = 0.3\text{A}, di/dt = 0.3\text{A}/\mu\text{s}, T_J = 125^\circ\text{C}$				150	A/ $\mu\text{s}$

# MMK110A160DA/DK

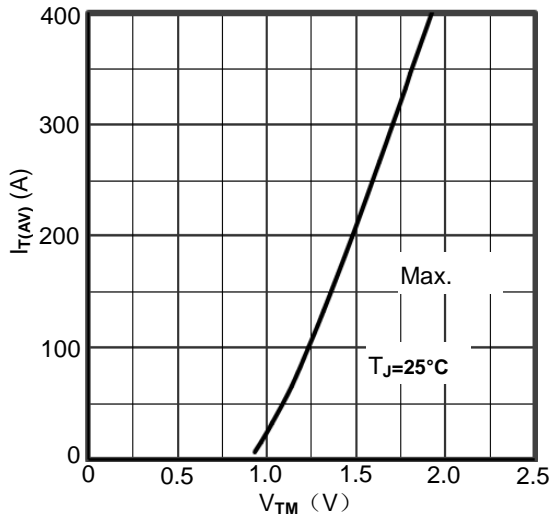

Figure1. SCR Average On-State Current vs. Forward Voltage

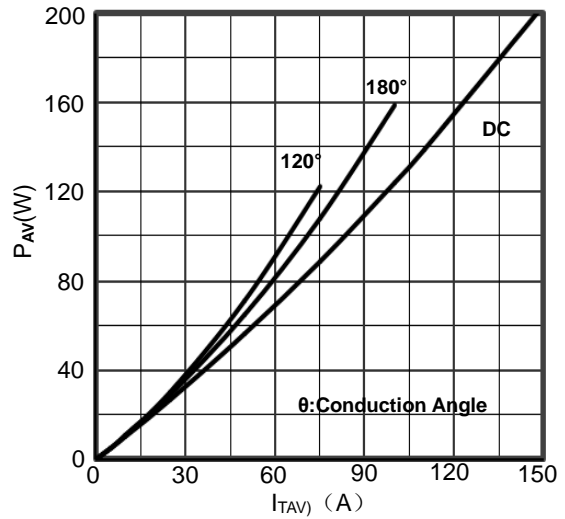

Figure2. SCR Power dissipation vs.  $I_{T(AV)}$

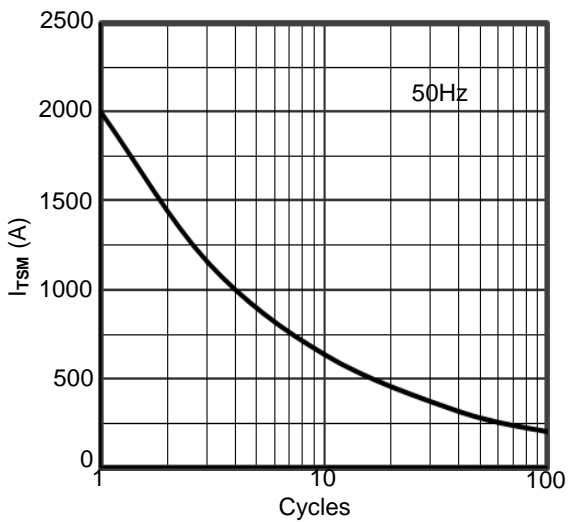

Figure3. Max Non-Repetitive Surge On-State Current

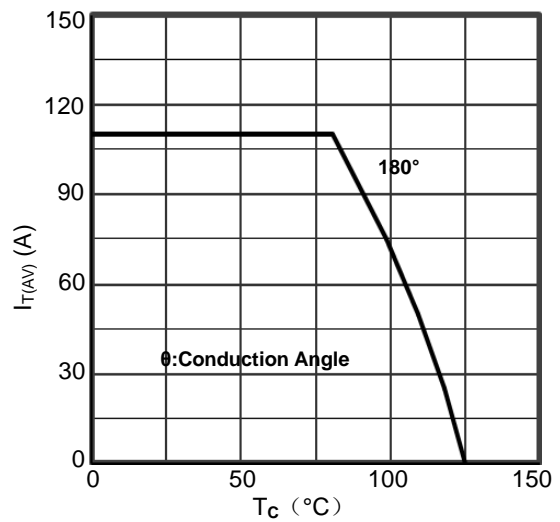

Figure4. On-State current vs. Case temperature

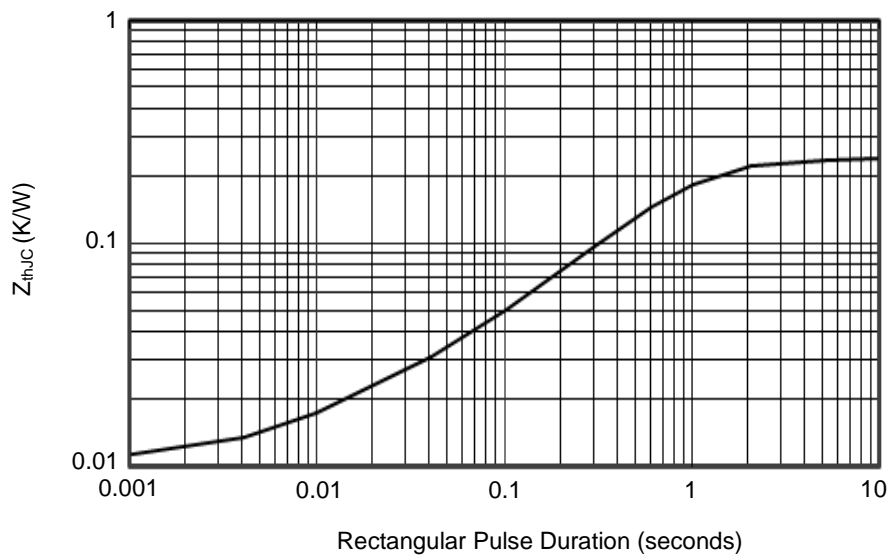

Figure5. Transient Thermal Impedance

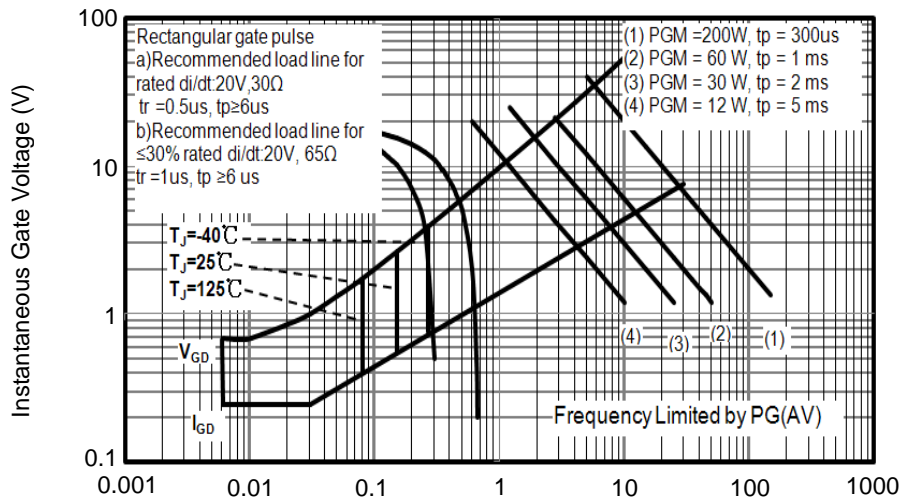
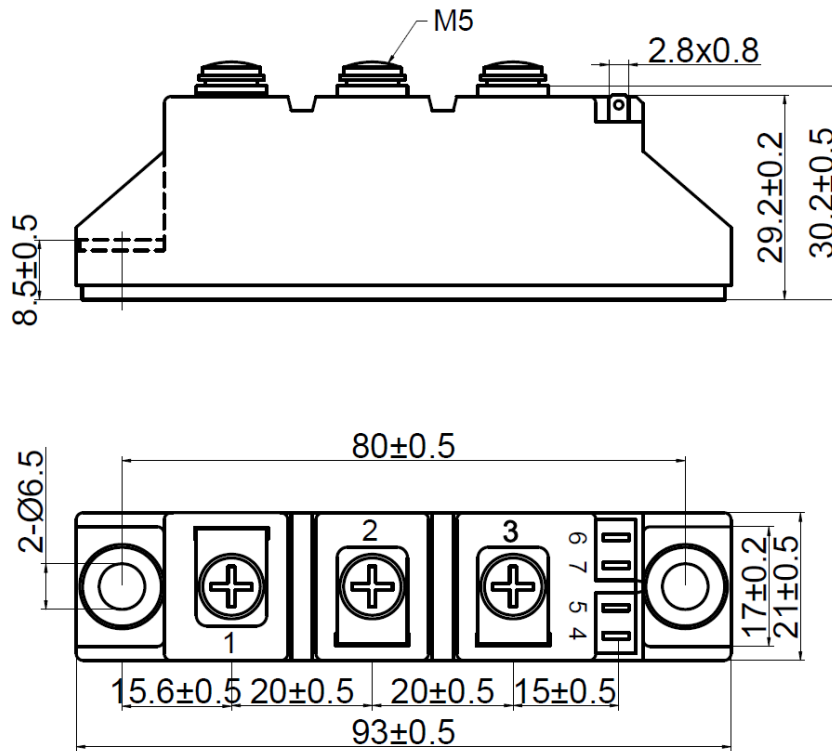

Figure6. Gate Characteristics



Dimensions in Millimeters  
Figure7. Package Outline